

Varenummer: 438000320

Beskrivelse: Rota-fix spændelement SD 320

## Mål

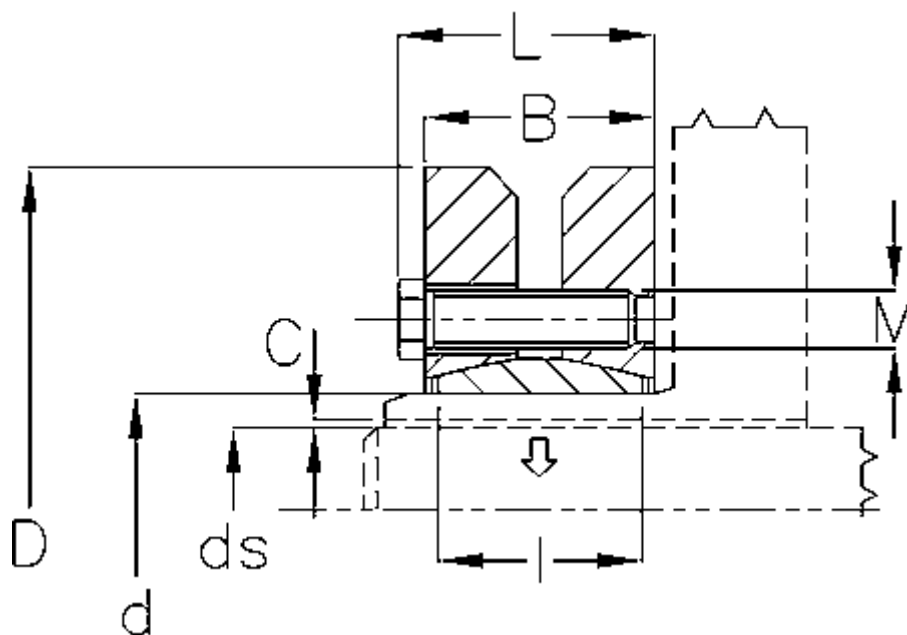

B mm	= 142
C maks.	= 0,111
d H8 mm	= 320
D mm	= 520
ds mm	= 240
F kN aksialkraft	= 2640
L mm	= 155
l mm	= 122

M mm	= M20
T Nm drejningsmoment	= 311000
Ts Nm boltetilspændingsmoment	= 490